

NCP584

Tri-Mode 200 mA CMOS LDO Regulator with Enable

The NCP584 series of low drop out regulators are designed for portable battery powered applications which require precise output voltage accuracy, low supply current, and high ripple rejection. These devices feature an enable function which lowers current consumption significantly and are offered in the SOT23-5 package.

This series of devices have three modes. Chip Enable (CE mode), Fast Transient Mode (FT mode), and Low Power Mode (LP mode). Both the FT and LP mode are utilized via the ECO pin.

Features

- Low Dropout Voltage of 300 mV at 200 mA, Output Voltage = 1.0 V
200 mV at 200 mA, Output Voltage = 1.5 V
140 mV at 200 mA, Output Voltage = 3.0 V
- Excellent Line and Load Regulation
- High Output Voltage Accuracy of $\pm 2\%$ ($\pm 3\%$ LP mode)
- Ultra-Low Supply Current of:
 - 3.5 μA (LP mode, Output Voltage ≤ 1.5 V)
 - 40 μA (FT mode)
- Excellent Power Supply Rejection Ratio
- Low Temperature Drift Coefficient on the Output Voltage
- Low Quiescent Current of 0.1 μA
- This is a Pb-Free Device*

Typical Applications

- Portable Equipment
- Hand-Held Instrumentation
- Camcorders and Cameras

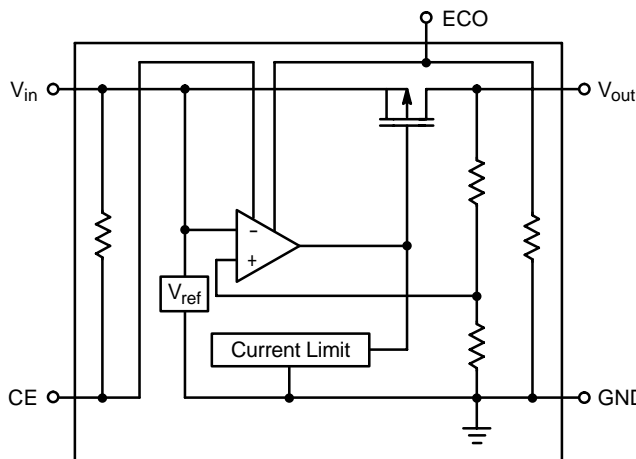

Figure 1. Simplified Block Diagram for Active Low

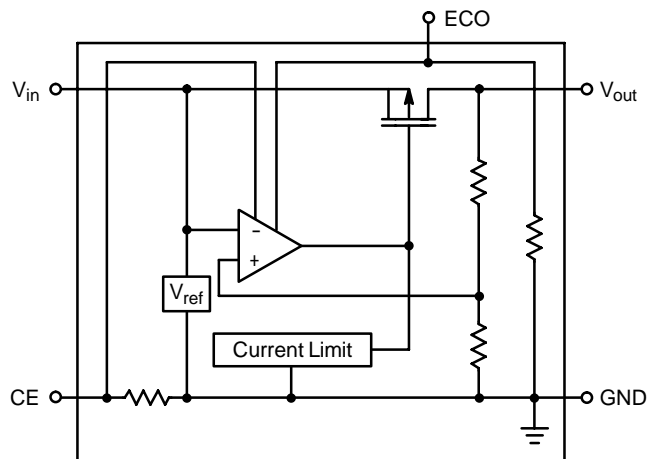

Figure 2. Simplified Block Diagram for Active High



ON Semiconductor®

<http://onsemi.com>

MARKING DIAGRAM



SOT23-5
SN SUFFIX
CASE 1212

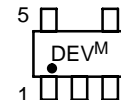

DEV = Device Code
M = Date Code

ORDERING INFORMATION

See detailed ordering and shipping information in the package dimensions section on page 11 of this data sheet.

*For additional information on our Pb-Free strategy and soldering details, please download the ON Semiconductor Soldering and Mounting Techniques Reference Manual, SOLDERRM/D.

NCP584

PIN FUNCTION DESCRIPTION

SOT23-5	Pin Name	Description
1	V _{in}	Power supply input voltage.
2	GND	Power supply ground.
3	$\overline{\text{CE}}$ or CE	Chip enable pin.
4	ECO	Mode alternative pin.
5	V _{out}	Regulated output voltage.

MAXIMUM RATINGS

Rating	Symbol	Value	Unit
Input Voltage	V _{in}	6.5	V
Input Voltage ($\overline{\text{CE}}$ or CE Pin)	V _{CE}	-0.3 to V _{in} +0.3	V
Input Voltage (ECO Pin)	V _{ECO}	-0.3 to V _{in} +0.3	V
Output Voltage	V _{out}	-0.3 to V _{in} +0.3	V
Output Current	I _{out}	250	mA
Power Dissipation	P _D	250	mW
Operating Junction Temperature Range	T _J	-40 to +85	°C
Storage Temperature Range	T _{stg}	+150	°C

Maximum ratings are those values beyond which device damage can occur. Maximum ratings applied to the device are individual stress limit values (not normal operating conditions) and are not valid simultaneously. If these limits are exceeded, device functional operation is not implied, damage may occur and reliability may be affected.

ELECTRICAL CHARACTERISTICS (V_{in} = V_{out} + 1.0 V, T_A = 25°C, unless otherwise noted.)

Characteristic	Symbol	Min	Typ	Max	Unit
Input Voltage	V _{in}	1.4	-	6.0	V
Output Voltage (1.0 μA ≤ I _{out} ≤ 30 mA) V _{ECO} = V _{in} V _{ECO} = GND	V _{out}	V _{out} X 0.980 V _{out} X 0.970	- -	V _{out} X 1.020 V _{out} X 1.030	V
Line Regulation (I _{out} = 30 mA, V _{out} + 0.5 V ≤ V _{in} ≤ 6.0 V) FT Mode V _{ECO} = V _{in} LP Mode V _{ECO} = GND	Reg _{line}	- -	0.05 0.10	0.20 0.30	%/V
Load Regulation FT Mode (1.0 mA ≤ I _{out} ≤ 200 mA), V _{ECO} = V _{in} LP Mode (1.0 mA ≤ I _{out} ≤ 100 mA), V _{ECO} = GND	Reg _{load}	- -	20 10	40 40	mV
Dropout Voltage (I _{out} = 200 mA) 0.8 ≤ V _{out} ≤ 0.9 V 1.0 ≤ V _{out} ≤ 1.4 V 1.5 ≤ V _{out} ≤ 2.5 V 2.6 ≤ V _{out} ≤ 3.1 V	V _{DO}	- - - -	0.40 0.30 0.20 0.10	0.70 0.50 0.30 0.20	V
Power Supply Current (I _{out} = 0 mA) FT Mode, V _{ECO} = V _{in} LP Mode, V _{ECO} = GND V _{out} ≤ 1.5 V V _{out} ≤ 1.6 V	I _{supply}	- - -	40 3.5 4.5	70 6.0 8.0	μA
Output Current (V _{in} - V _{out} = 0.5 V) V _{in} ≥ 1.5 V, V _{out} ≤ 1.0 V	I _{out}	200	-	-	mA
Quiescent Current (V _{CE} = V _{in})	I _Q	-	0.1	1.0	μA
Output Short Circuit Current (V _{out} = 0 V)	I _{lim}	-	50	-	mA
Enable Input Threshold Voltage High, ECO Input Voltage = High Low, ECO Input Voltage = Low	V _{th_{enh}} V _{th_{enl}}	1.0 0	- -	V _{in} 0.3	V

TYPICAL CHARACTERISTICS

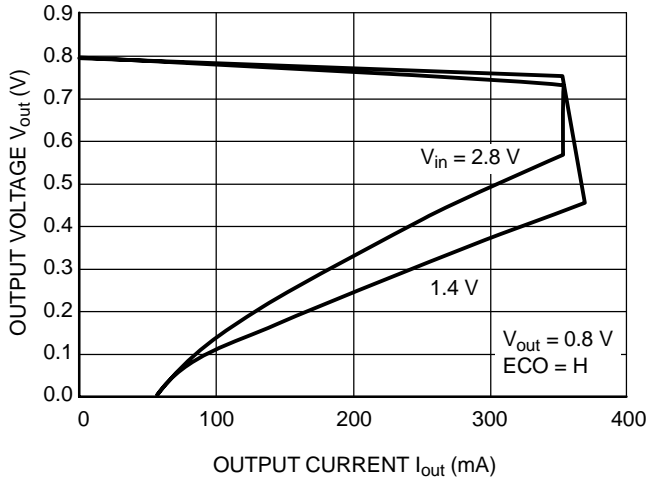

Figure 3. Output Voltage vs. Output Current

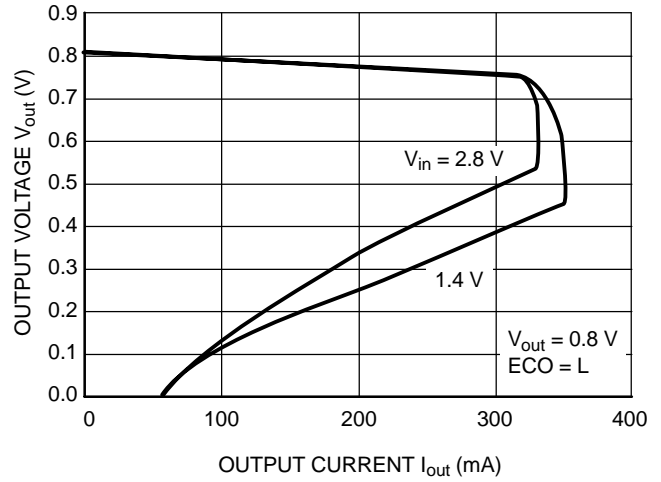

Figure 4. Output Voltage vs. Output Current

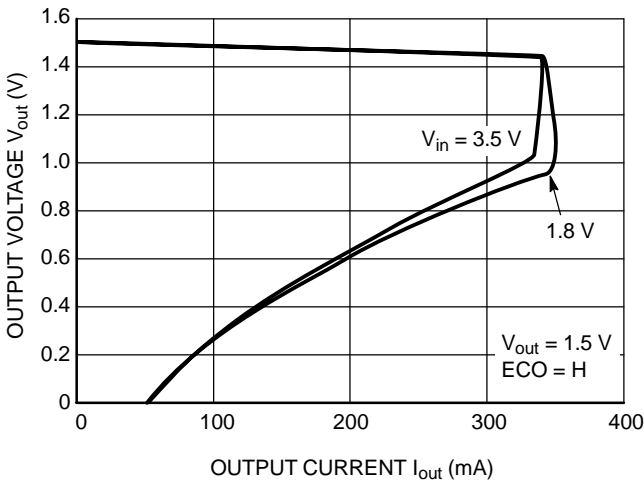

Figure 5. Output Voltage vs. Output Current

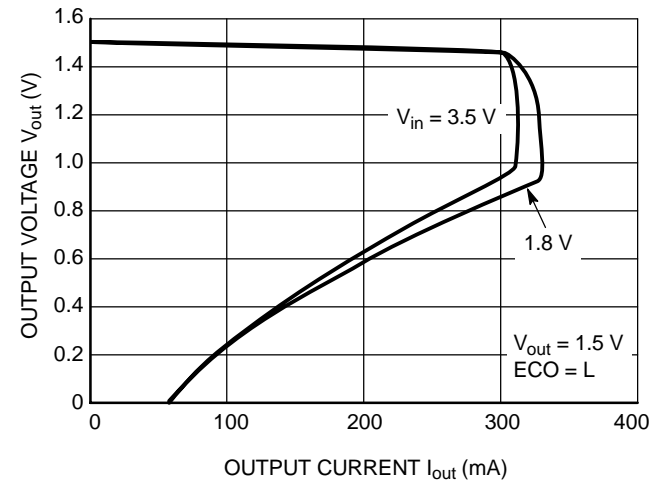

Figure 6. Output Voltage vs. Output Current

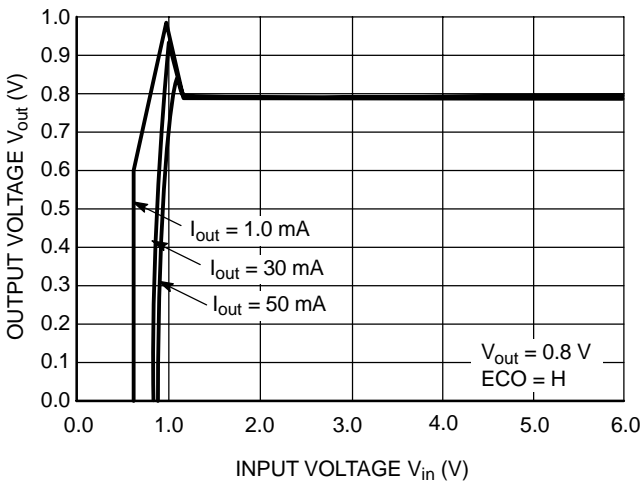

Figure 7. Output Voltage vs. Input Voltage

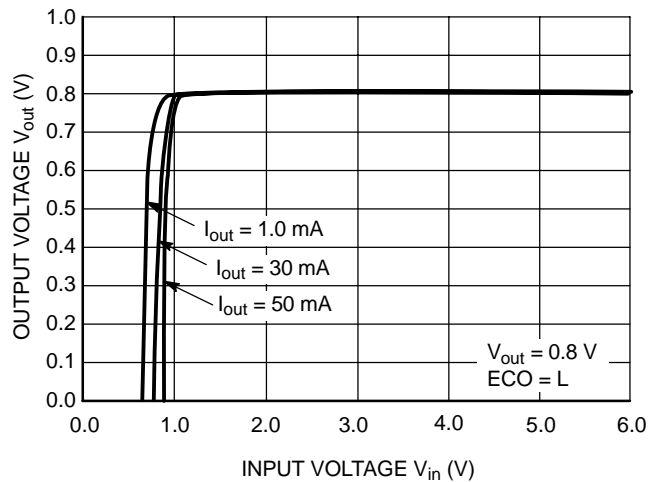

Figure 8. Output Voltage vs. Input Voltage

TYPICAL CHARACTERISTICS

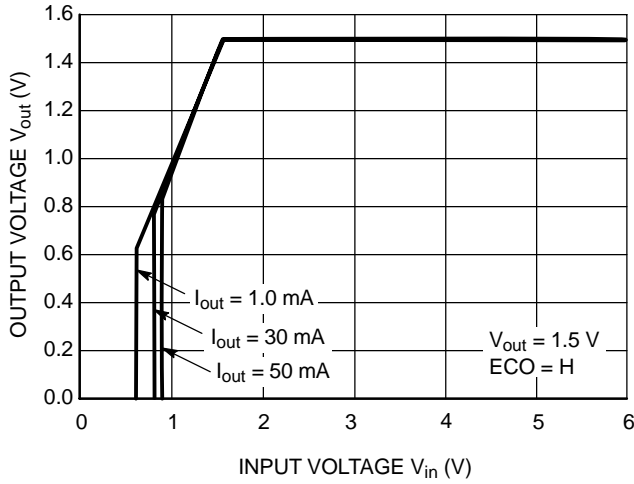

Figure 9. Output Voltage vs. Input Voltage

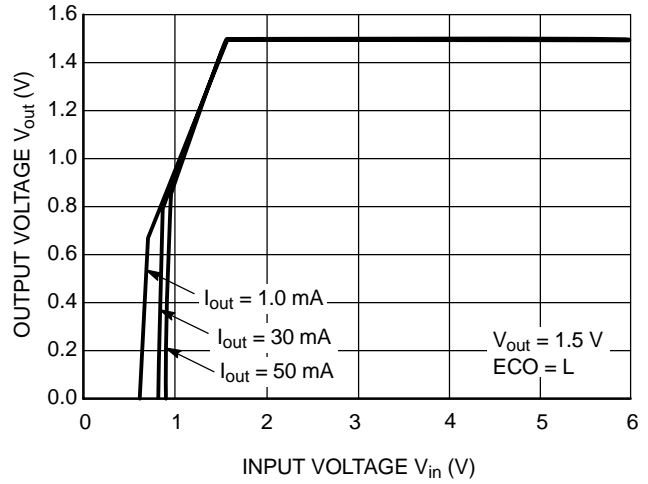

Figure 10. Output Voltage vs. Input Voltage

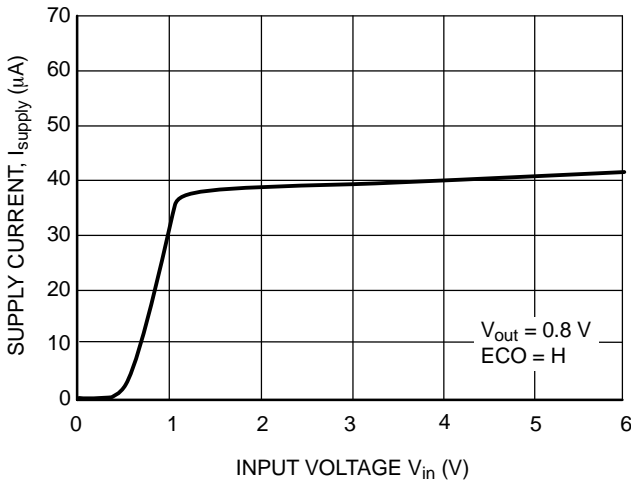

Figure 11. Power Supply Current vs. Input Voltage

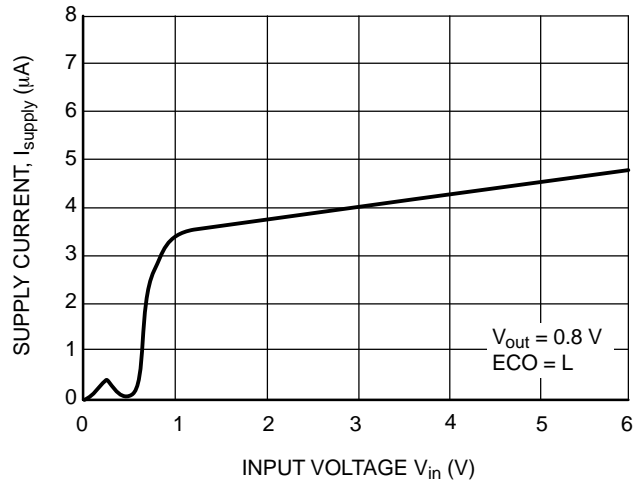

Figure 12. Power Supply Current vs. Input Voltage

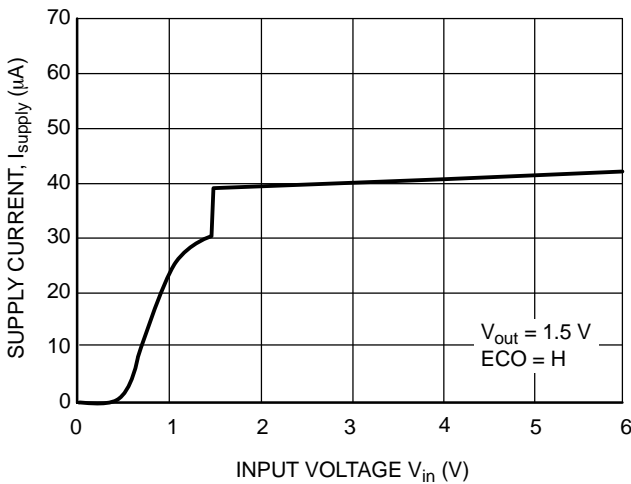

Figure 13. Power Supply Current vs. Input Voltage

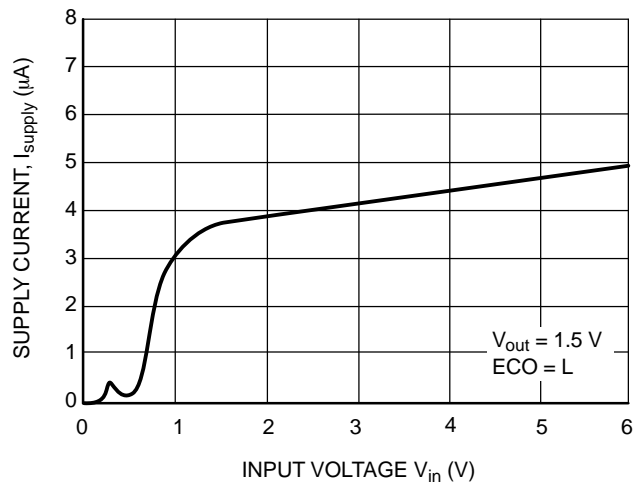

Figure 14. Power Supply Current vs. Input Voltage

TYPICAL CHARACTERISTICS

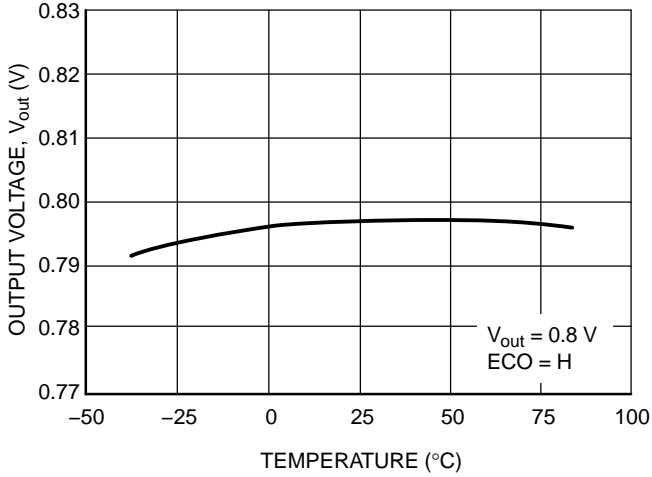

Figure 15. Output Voltage vs. Temperature

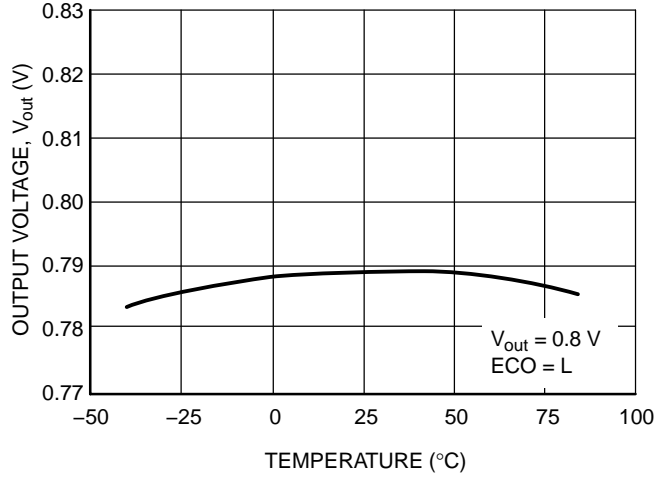

Figure 16. Output Voltage vs. Temperature

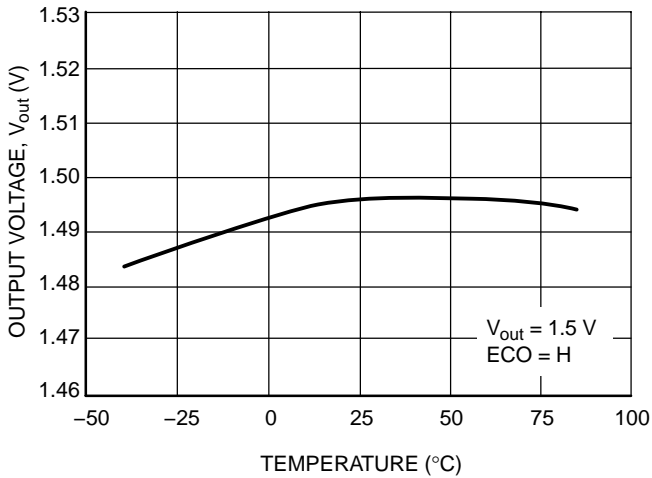

Figure 17. Output Voltage vs. Temperature

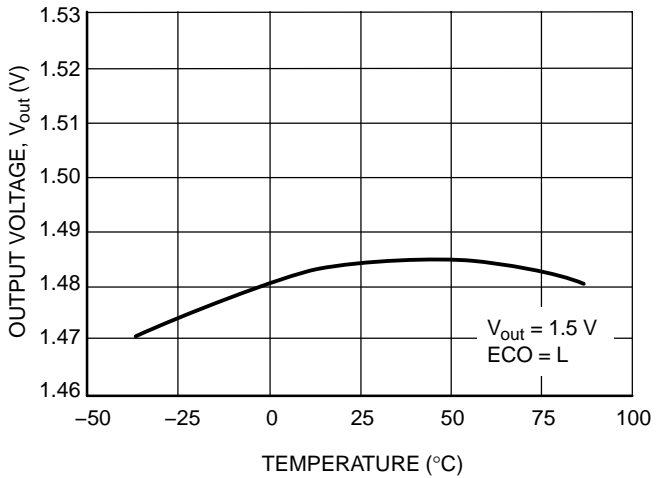

Figure 18. Output Voltage vs. Temperature

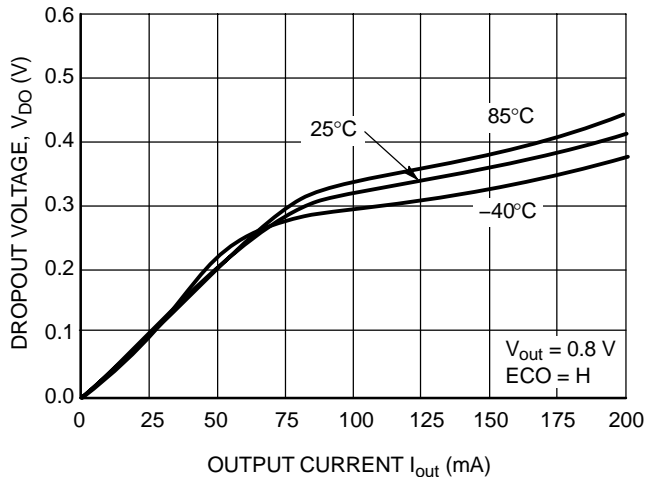

Figure 19. Dropout Voltage vs. Output Current

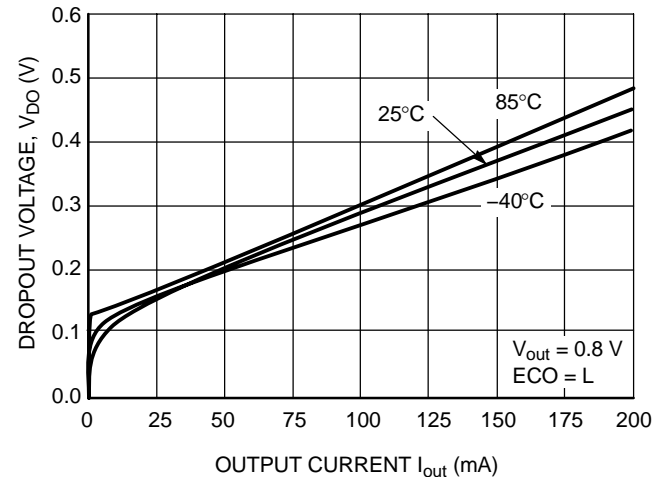

Figure 20. Dropout Voltage vs. Output Current

TYPICAL CHARACTERISTICS

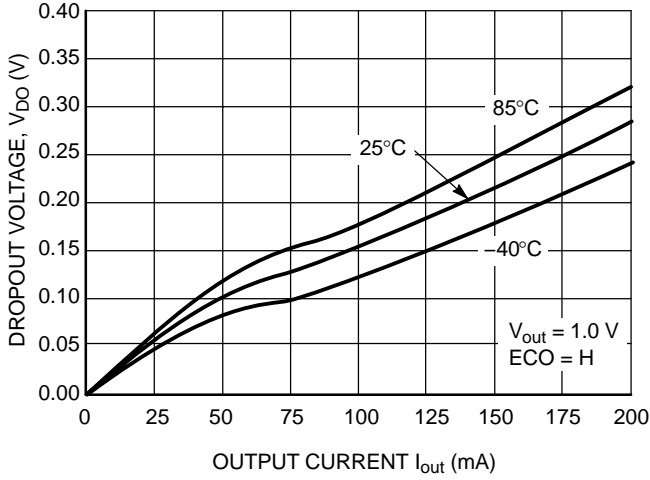

Figure 21. Dropout Voltage vs. Output Current

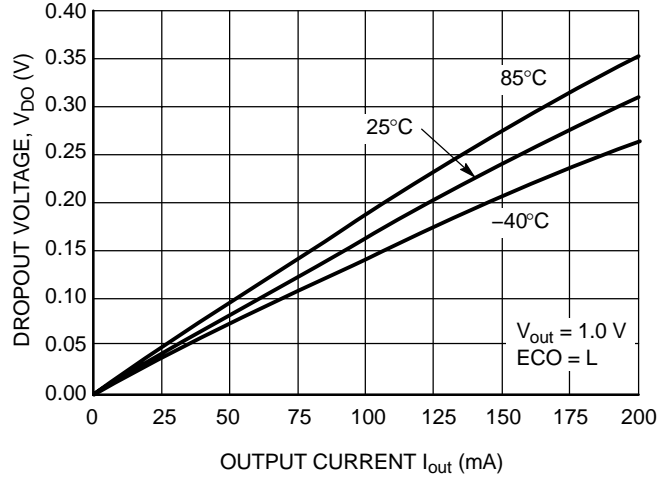

Figure 22. Dropout Voltage vs. Output Current

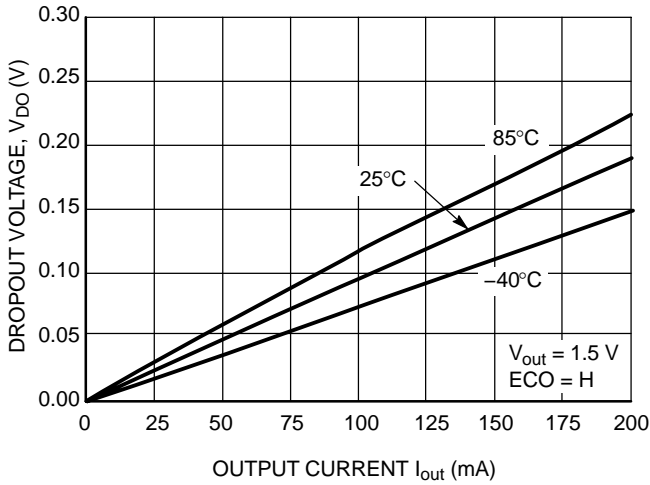

Figure 23. Dropout Voltage vs. Output Current

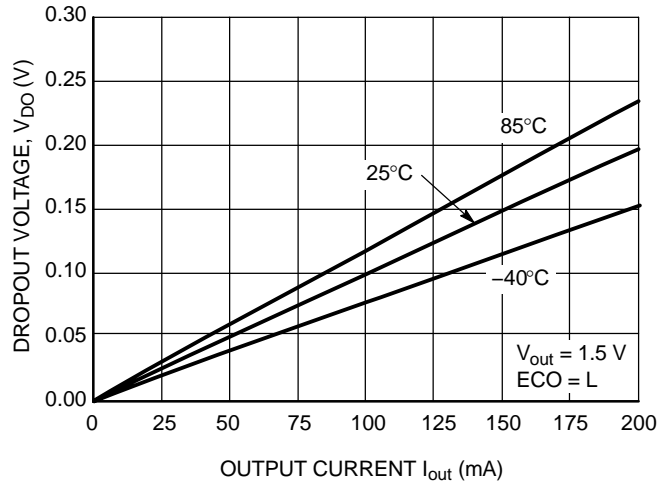

Figure 24. Dropout Voltage vs. Output Current

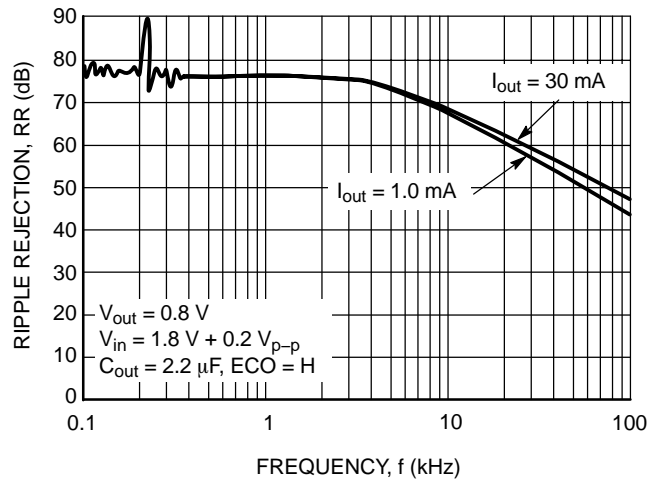

Figure 25. Ripple Rejection vs. Frequency

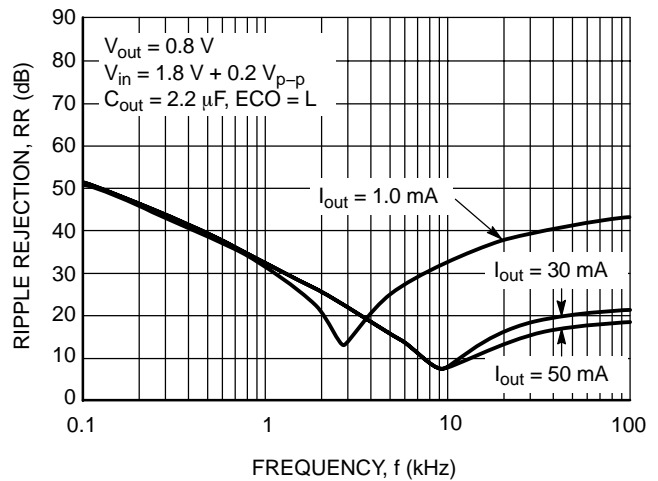

Figure 26. Ripple Rejection vs. Frequency

TYPICAL CHARACTERISTICS

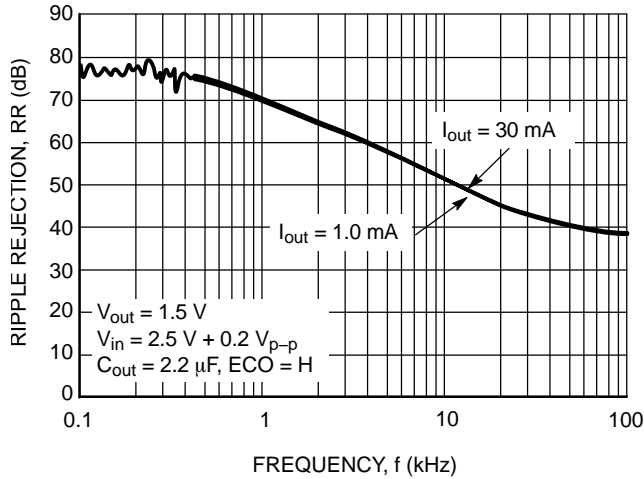

Figure 27. Ripple Rejection vs. Frequency

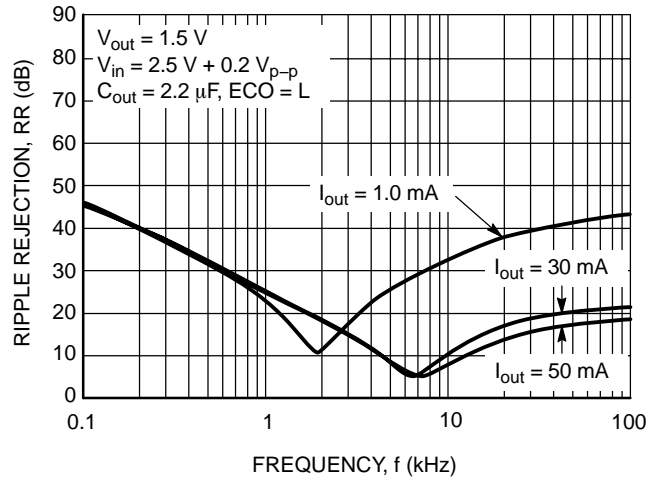

Figure 28. Ripple Rejection vs. Frequency

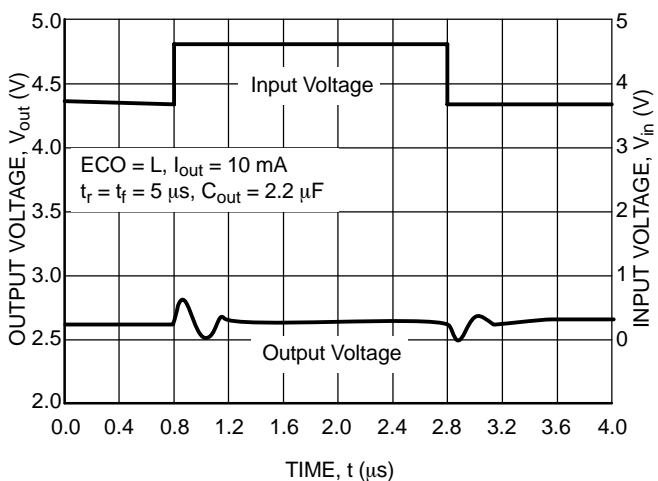
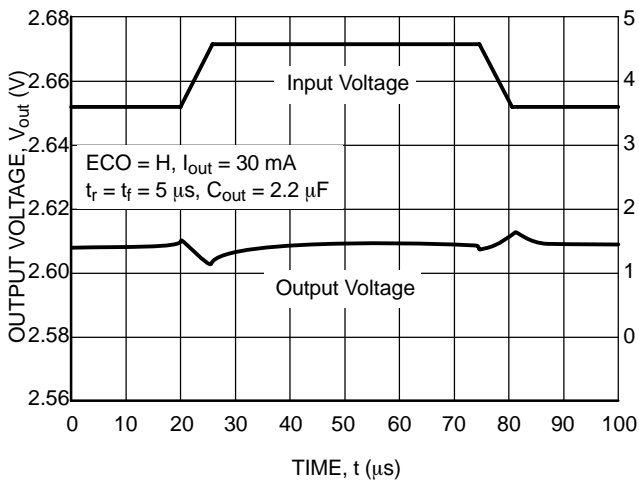
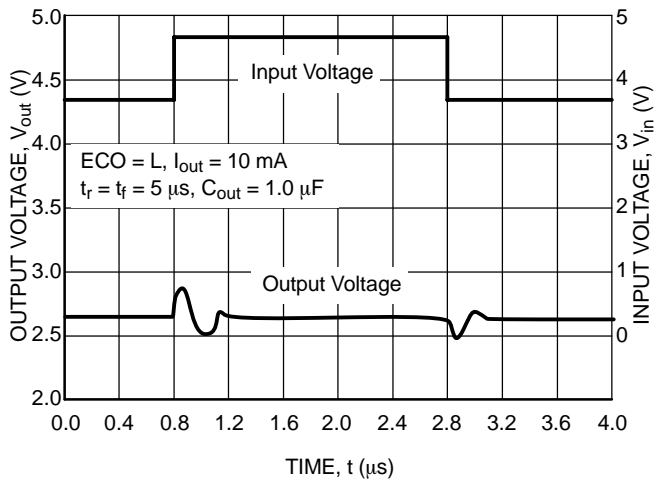
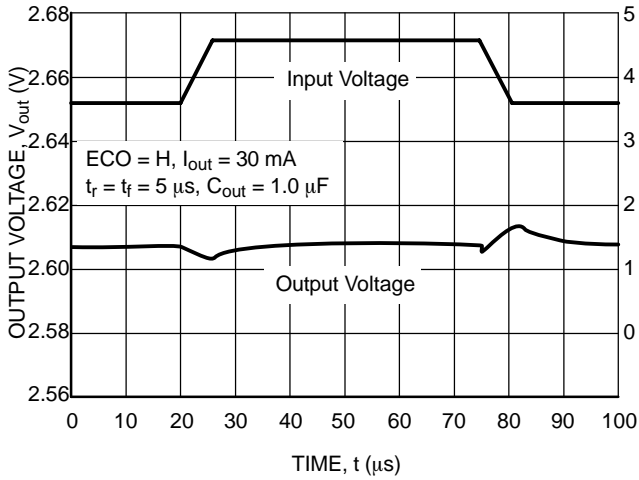

Figure 29. Input Transient Response ($V_{out} = 2.6 V$)

TYPICAL CHARACTERISTICS

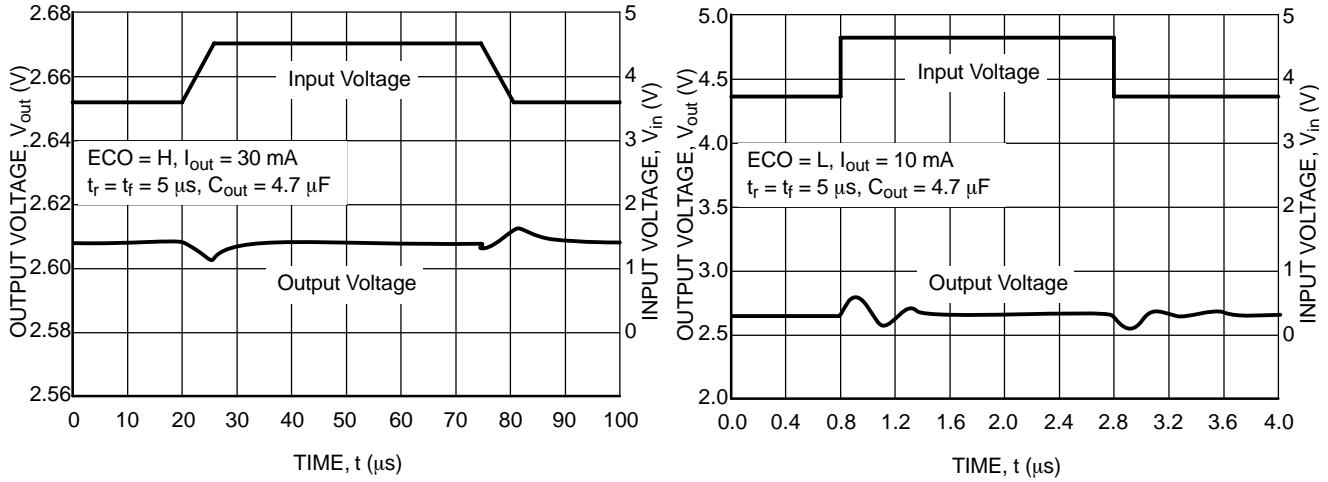

Figure 29. (continued) Input Transient Response ($V_{out} = 2.6\text{ V}$)

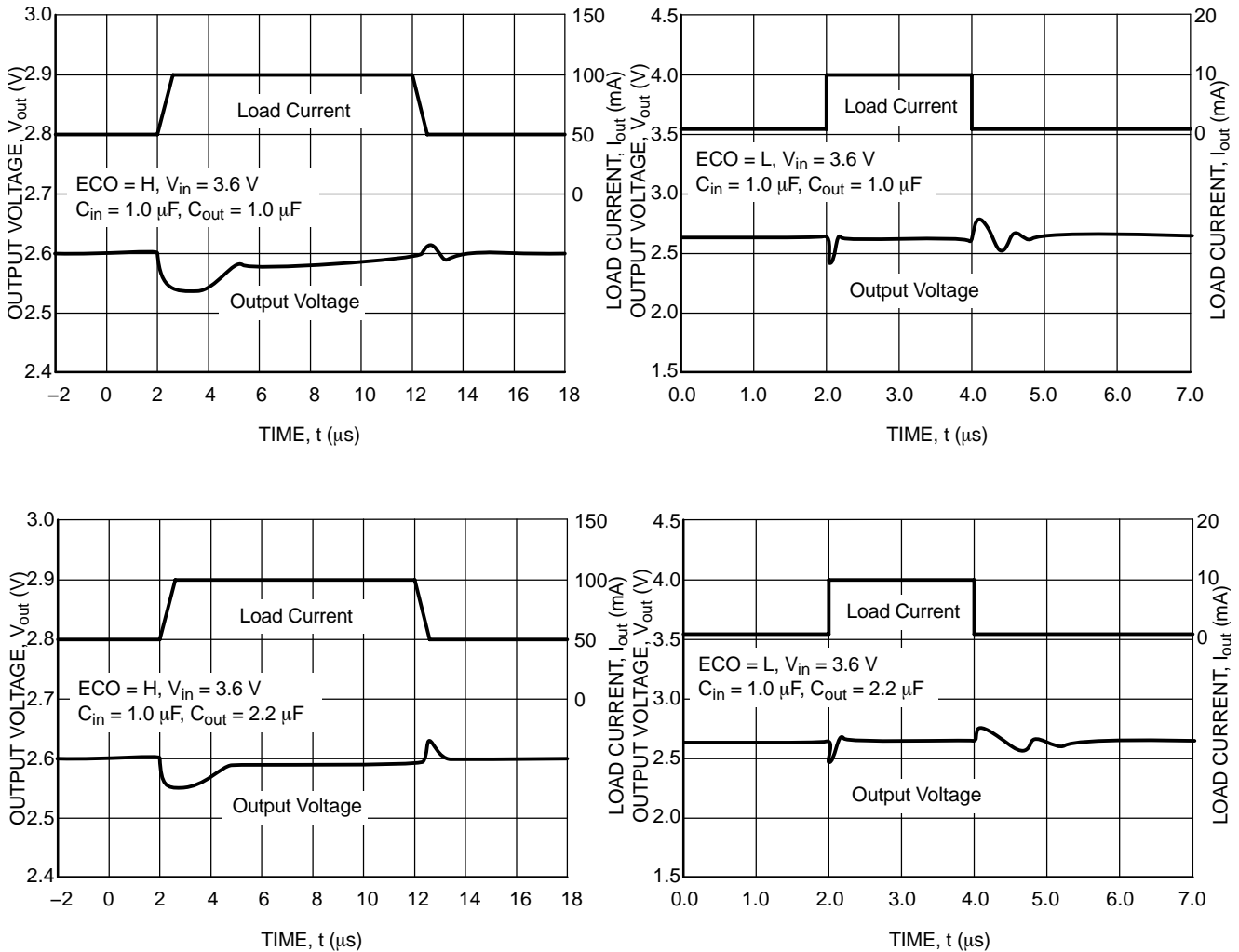

Figure 30. Load Transient Response ($V_{out} = 2.6\text{ V}$)

TYPICAL CHARACTERISTICS

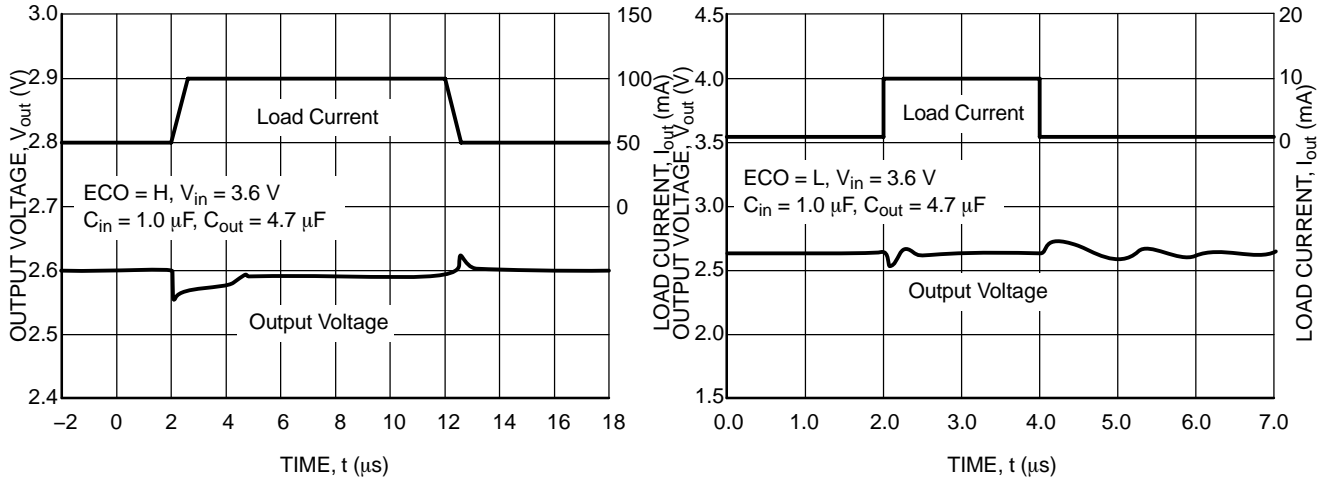

Figure 30. (continued) Load Transient Response ($V_{out} = 2.6\text{ V}$)

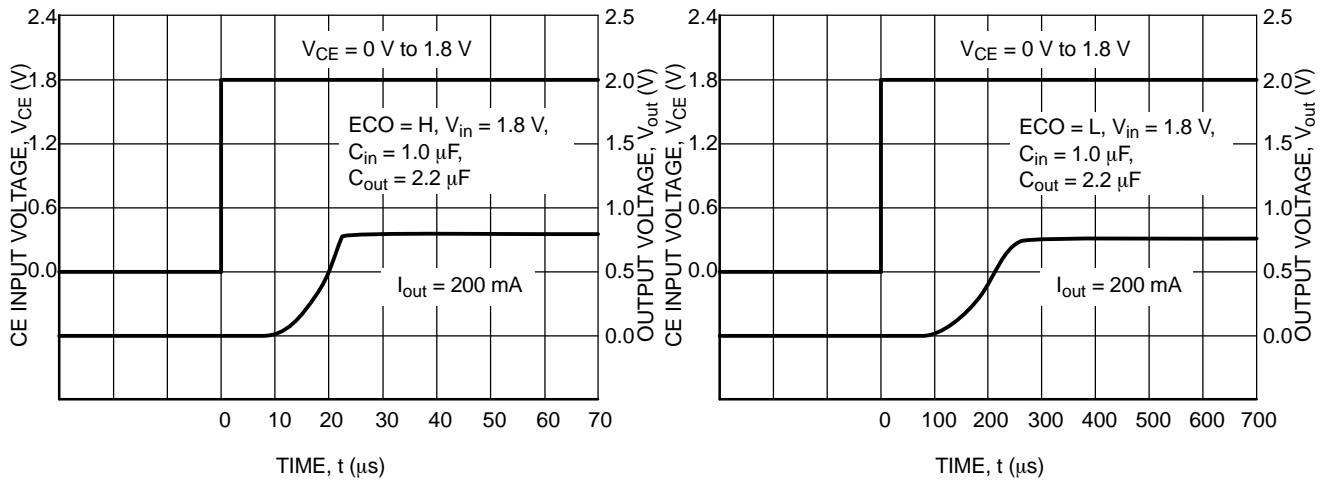

Figure 31. Turn-On/Off Speed with CE Pin ($V_{out} = 0.8\text{ V}$)

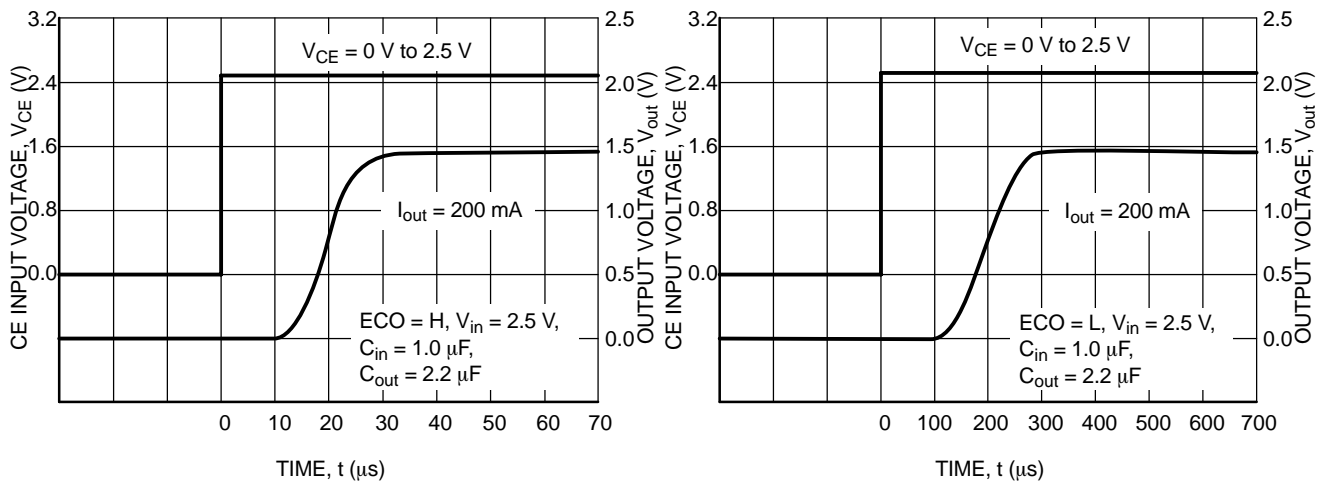

Figure 32. Turn-On/Off Speed with CE Pin ($V_{out} = 1.5\text{ V}$)

NCP584

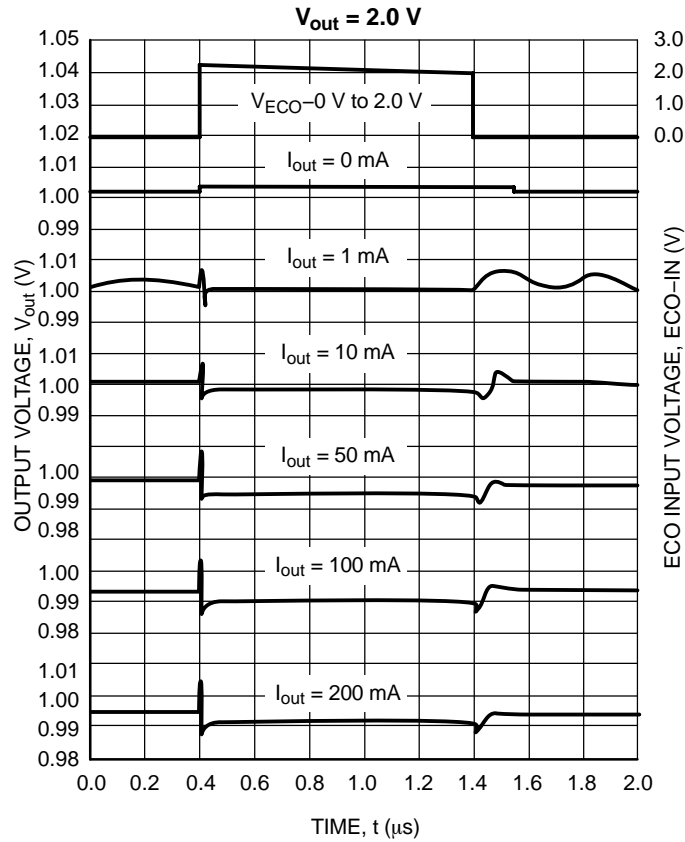
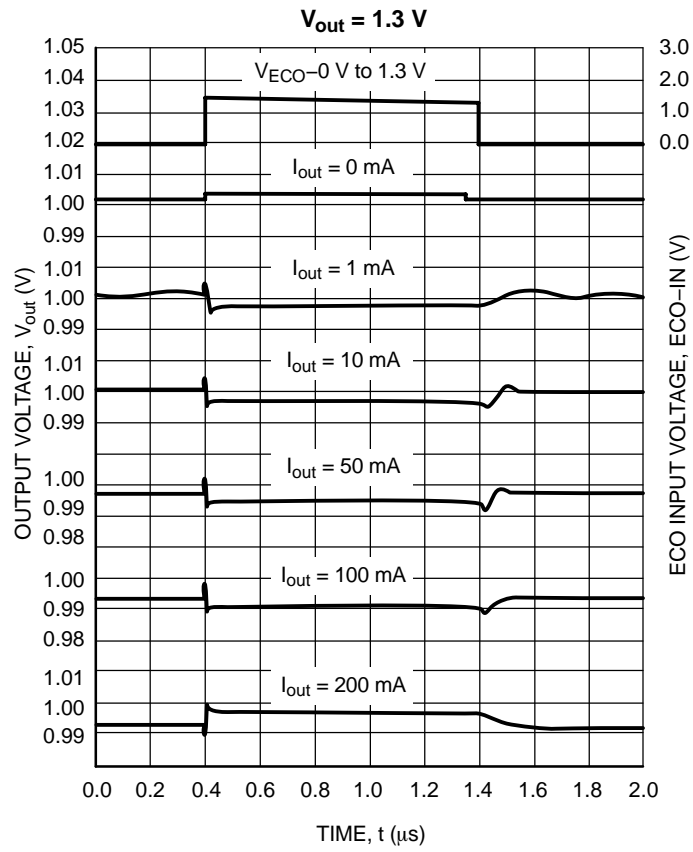

Figure 33. Output Voltage at Mode Alternative Point
($C_{in} = 1.0\ \mu\text{F}$, $C_{out} = 2.2\ \mu\text{F}$, 8.0 V , $V_{out} = 1.0\text{ V}$)

NCP584

APPLICATION INFORMATION

Input Decoupling

A 1.0 μF tantalum capacitor is the recommended value to be connected between V_{in} and GND. For PCB layout considerations, the traces of V_{in} and GND should be sufficiently wide in order to minimize noise and prevent unstable operation.

Output Decoupling

It is recommended to use a 2.2 μF or higher tantalum capacitor on the V_{out} pin. For better performance, select a capacitor with low Equivalent Series Resistance (ESR). For PCB layout considerations, place the output capacitor close to the output pin and keep the leads short as possible.

ORDERING INFORMATION

Device	Output Type / Features	Nominal Output Voltage	Marking	Package	Shipping†
NCP584HSN09T1G	Active High, LP and FT Mode	0.9	109	SOT23-5 (Pb-Free)	3000 Tape & Reel
NCP584HSN12T1G	Active High, LP and FT Mode	1.2	112	SOT23-5 (Pb-Free)	3000 Tape & Reel
NCP584HSN15T1G	Active High, LP and FT Mode	1.5	115	SOT23-5 (Pb-Free)	3000 Tape & Reel
NCP584HSN18T1G	Active High, LP and FT Mode	1.8	118	SOT23-5 (Pb-Free)	3000 Tape & Reel
NCP584HSN26T1G	Active High, LP and FT Mode	2.6	126	SOT23-5 (Pb-Free)	3000 Tape & Reel
NCP584HSN31T1G	Active High, LP and FT Mode	3.1	131	SOT23-5 (Pb-Free)	3000 Tape & Reel
NCP584LSN09T1G	Active Low, LP and FT Mode	0.9	009	SOT23-5 (Pb-Free)	3000 Tape & Reel
NCP584LSN12T1G	Active Low, LP and FT Mode	1.2	012	SOT23-5 (Pb-Free)	3000 Tape & Reel
NCP584LSN18T1G	Active Low, LP and FT Mode	1.8	018	SOT23-5 (Pb-Free)	3000 Tape & Reel

†For information on tape and reel specifications, including part orientation and tape sizes, please refer to our Tape and Reel Packaging Specification Brochure, BRD8011/D.

NCP584

PACKAGE DIMENSIONS

SOT23-5
SN SUFFIX
CASE 1212-01
ISSUE O

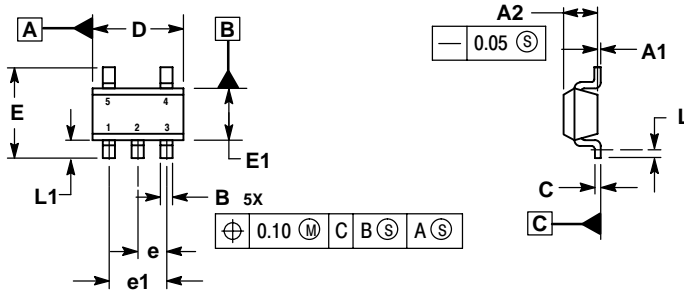

NOTES:

1. DIMENSIONS ARE IN MILLIMETERS.
2. INTERPRET DIMENSIONS AND TOLERANCES PER ASME Y14.5M, 1994.
3. DATUM C IS A SEATING PLANE.

MILLIMETERS		
DIM	MIN	MAX
A1	0.00	0.10
A2	1.00	1.30
B	0.30	0.50
C	0.10	0.25
D	2.80	3.00
E	2.50	3.10
E1	1.50	1.80
e	0.95 BSC	
e1	1.90 BSC	
L	0.20	---
L1	0.45	0.75

ON Semiconductor and are registered trademarks of Semiconductor Components Industries, LLC (SCILLC). SCILLC reserves the right to make changes without further notice to any products herein. SCILLC makes no warranty, representation or guarantee regarding the suitability of its products for any particular purpose, nor does SCILLC assume any liability arising out of the application or use of any product or circuit, and specifically disclaims any and all liability, including without limitation special, consequential or incidental damages. "Typical" parameters which may be provided in SCILLC data sheets and/or specifications can and do vary in different applications and actual performance may vary over time. All operating parameters, including "Typicals" must be validated for each customer application by customer's technical experts. SCILLC does not convey any license under its patent rights nor the rights of others. SCILLC products are not designed, intended, or authorized for use as components in systems intended for surgical implant into the body, or other applications intended to support or sustain life, or for any other application in which the failure of the SCILLC product could create a situation where personal injury or death may occur. Should Buyer purchase or use SCILLC products for any such unintended or unauthorized application, Buyer shall indemnify and hold SCILLC and its officers, employees, subsidiaries, affiliates, and distributors harmless against all claims, costs, damages, and expenses, and reasonable attorney fees arising out of, directly or indirectly, any claim of personal injury or death associated with such unintended or unauthorized use, even if such claim alleges that SCILLC was negligent regarding the design or manufacture of the part. SCILLC is an Equal Opportunity/Affirmative Action Employer. This literature is subject to all applicable copyright laws and is not for resale in any manner.

PUBLICATION ORDERING INFORMATION

LITERATURE FULFILLMENT:
Literature Distribution Center for ON Semiconductor
P.O. Box 5163, Denver, Colorado 80217 USA
Phone: 303-675-2175 or 800-344-3860 Toll Free USA/Canada
Fax: 303-675-2176 or 800-344-3867 Toll Free USA/Canada
Email: orderlit@onsemi.com

N. American Technical Support: 800-282-9855 Toll Free USA/Canada

Japan: ON Semiconductor, Japan Customer Focus Center
2-9-1 Kamimeguro, Meguro-ku, Tokyo, Japan 153-0051
Phone: 81-3-5773-3850

ON Semiconductor Website: <http://onsemi.com>

Order Literature: <http://www.onsemi.com/litorder>

For additional information, please contact your local Sales Representative.